

Produktbild
Product picture



Distanzplatte 3mm

Spacer Plate 3mm

Artikelnummer: 105011008

Distanzplatte zum Ausgleichen des Abstandes zwischen Basis 100 und Dachsparren



System	assembly system	Delta	
Komponententyp	type of component	Distanzplatte	spacer plate
Materialien	materials	Aluminium	aluminum
Gewicht Einzelteil	unit weight	83	[g]



Distanzplatte 3 mm

Spacer Plate 3 mm

Artikelnummer: 105011008

Distanzplatte zum Ausgleichen des Abstandes zwischen Basis 100 und Dachsparren

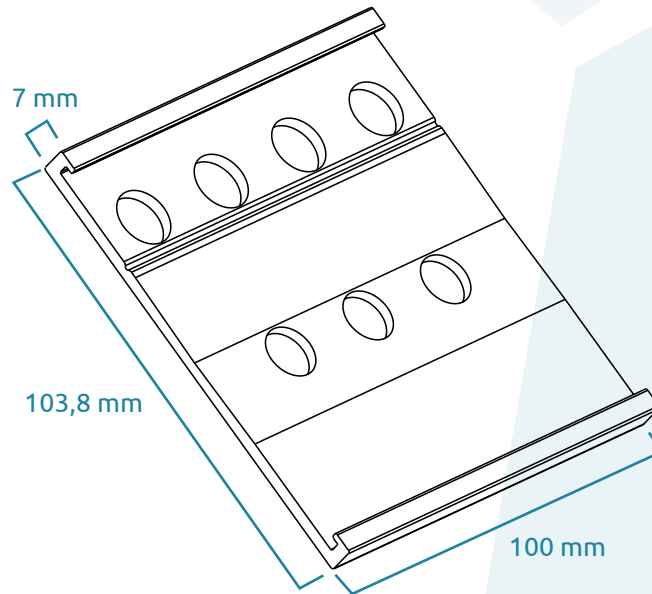

System	assembly system	Delta	
Komponententyp	type of component	Distanzplatte	spacer plate
Materialien	materials	Aluminium	aluminum
Gewicht Einzelteil	unit weight	83	[g]
<i>Weitere Informationen</i>			
Karton/Box-Maße	box dimensions	34 x 26 x 12	[cm]
Gebindegröße	units per box	150	[stk]
Gewicht je Karton (brutto)	weight per box (gross)	12,7	[kg]
Kartons/Boxen je Palette	boxes per pallet	96	[stk]
Paletten-Maße	pallet size	-	[cm]
Gewicht je Palette (brutto)	weight per pallet (gross)	-	[kg]